

# Fiber Optic Cable Puller Trailer



**CONDUX**

**ISO 9001:2008**  
**CERTIFIED**

# ***Important Safety Notice***

---

Read and understand these usage and safety instructions before using a Condux Fiber Optic Cable Puller Trailer. Observe all safety information on this page and note specific safety requirements as explained by procedures called out in this manual. Failure to follow these instructions could result in serious personal injury or death. Save this user's guide for future reference.

## **ADVERTENCIA:**

Favor de leer y comprender todas las instrucciones de operación y seguridad antes de usar la máquina. Si Ud. no comprende las instrucciones favor de consultarle a su jefe.

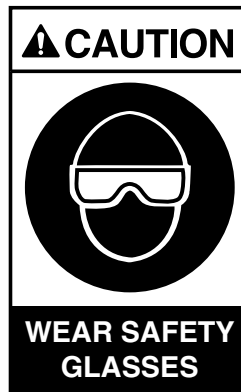
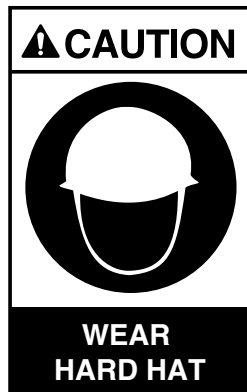
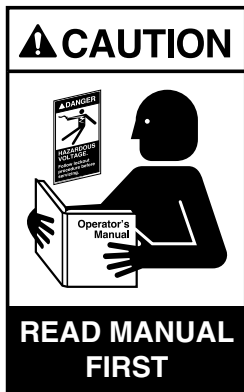

If you have questions on:  
SAFETY - OPERATIONS - APPLICATIONS  
CALL 1-800-533-2077

# Table of Contents

---

<b>1.</b>	<b>General Information</b>	
	Fiber Optic Cable Puller Trailer .....	4
<b>2.</b>	<b>Product Specifications</b>	
	General Dimensions .....	4
	Power Supply Specifications .....	4
	Hydraulic Specifications .....	5
	Other Specifications .....	5
<b>3.</b>	<b>Safe Operating Practices</b>	
	Work Area Safety .....	5
	Hydraulic Systems .....	5
	Electrical Components .....	6
<b>4.</b>	<b>Jobsite Floor Plan</b>	
	Jobsite Floor Plan Illustration .....	6
<b>5.</b>	<b>Set Up The Trailer</b>	
	Stabilizing & Leveling the Trailer .....	7
<b>6.</b>	<b>Set up the Cable Puller</b>	
	Cable Pulling from Trailer .....	9
	Cable Pulling with the Remote Mounting Stand .....	9
	Unpack the Components .....	10
	Connect the Hydraulics .....	10
<b>7.</b>	<b>Set up the Electronic Control System</b>	
	Switch Configuration .....	12
	Connect the Electronics .....	12
	Setting up the Electronic Control Box .....	14
	Digital Chart Recorder Set up .....	15
	Data Download Instructions .....	16
<b>8.</b>	<b>Operating the Power Unit</b>	
	Fuel & Fuel Tank .....	16
	Final Inspection .....	17
	Start the Power Unit .....	17
<b>9.</b>	<b>When the Cable Pull is Complete</b>	
	Stop the Power Unit .....	18
	Remove Pressure from Hydraulic System .....	18
	Remove Hydraulic Hoses .....	18
	Disconnect the Electronics .....	19
<b>10.</b>	<b>Additional Takedown Procedures</b>	
	Remove Capstan from the Puller .....	19
	Return Puller to Travel Position .....	19
	Load Foot Control Unit .....	20
	Prepare Unit for Transport .....	20
<b>11.</b>	<b>Appendices</b>	
	A. Trailer Towing Safety Instructions .....	20
	B. Routine Maintenance .....	21
	C. Replacement Parts .....	21

# General Information

## 1.

Congratulations on your purchase of the Condux Fiber Optic Cable Puller Trailer. This unit is designed to provide a safe and efficient means to transport and operate the Condux Fiber Optic Cable Puller (figure 1). The trailer offers the platform for a self-contained cable pulling system including a hydraulic power source, cable puller mounts, leveling and stabilizing hardware, and a lockable storage area (figure 2).

This User Guide and Safety Manual will help you become more acquainted with the features and functions of your Fiber Optic Cable Puller Trailer. As with all Condux products, it is designed to be used only by trained craftspeople. Be certain that you understand the operating and safety instructions in this manual before using the equipment. Keep this manual as a permanent part of your trailer package.



Figure 1



Figure 2

# Product Specifications

## 2.

### A. GENERAL DIMENSIONS

Weight (wet) not including cable puller: 950 lbs.

Track: 60 inches

Overall width: 80 inches

Tongue weight: 200 lbs.

Tire Size: P205/75R14

Rim Size: 14" x 6"

Coupling Size: 3" Lunette Eye

Overall Height: 51 inches

Lighting adapter: 7 pin connector

### B. POWER SUPPLY SPECIFICATIONS

GAS-Briggs & Stratton V-Twin Vanguard OHV 16 h.p. gasoline engine, electric start

Fuel requirements: unleaded fuel only, 85 minimum octane, 10% or less ethanol blend

Fuel capacity: 5 gallons

### **C. HYDRAULIC SPECIFICATIONS**

Capacity: 8 gpm @ 2000 psi

Reservoir capacity: 5 gallons

Filtration: 10 micron nominal

Oil Requirements: Petroleum based hydraulic oil with antiwear properties and high viscosities over 140

Relief Valve Setting: 2150 psi

### **D. OTHER SPECIFICATIONS**

Electronics power requirements: 12 VDC

Pulling Capacity: 1000 lbs with 30" dia. Condux capstan

Towing Requirements: Class I hitch, 200 lbs. tongue weight, 2000 gross trailer weight

## ***Safe Operating Practices***

Your Fiber Optic Cable Puller Trailer, as with all Condux products, is designed for safe operation; however, general jobsite safety practices must be followed. In addition, specific safety messages are printed throughout this manual and also appear on safety labels on the product.



3.

### **A. WORK AREA SAFETY**

1. Read and understand all operating instructions and safety messages before operating.
2. Wear protective safety equipment such as: hard hat, safety glasses, safety shoes, work gloves.
3. The safe operation of this equipment requires that the operator(s) be on stable footing.
4. Stay clear of cable or lines under tension.
5. Be aware of the location of all underground utilities in your work area.
6. No smoking or open flame in the work area. An explosion hazard exists as the trailer houses a gasoline tank.

### **B. HYDRAULIC SYSTEMS**

Escaping fluids under pressure can penetrate the skin and cause serious personal injury. Observe the following precautions to avoid hydraulic hazards:

1. Tighten all connections before applying pressure. Relieve pressure before disconnecting hoses.
2. Check for leaks with a piece of cardboard. Do not use hands!
3. Do not exceed working pressure of hydraulic hoses.
4. Visually inspect hoses regularly and replace if damaged.

### C. ELECTRICAL COMPONENTS

The Electronic Control Box is an electrical device. Electric shock hazard exists that could result in severe personal injury or death. Observe the following precautions to avoid electrical hazards:

1. Do not operate in or near water. This includes setting the Electronic Control Box on a wet surface or exposing it to rain.
2. Do not remove cover of Electronic Control Box. No user-serviceable parts inside. Refer servicing to qualified service personnel.
3. The Electronic Control Box power switch should be in the off position before connecting or disconnecting any cords.

## Jobsite Floor Plan

# 4.

A few minutes spent planning your equipment's placement (layout) at the jobsite will benefit both the operation of the equipment and the safety of your personnel at the site. It is best to determine the layout of equipment before stabilizing and leveling the trailer (section 5A). Condux recognizes that no two jobsites are the same, but recommends a few general guidelines to get the most benefit and safest operation from your Fiber Optic Cable Puller Trailer.

### A. POSITION THE CABLE PULLER

Ultimately, the cable will be pulled from its exit point parallel to the capstan (figure 4). Several options are available on the Condux trailer to achieve this. The cable puller can be located in one of three mounts and rotated perpendicular or parallel in each. Review these options using the accompanying diagrams and determine where to position the trailer (figure 3).

### B. REMOTE MOUNTING STAND

If no suitable puller position can be achieved on the trailer, a remote mounting stand (supplied) may be used, see section 6B.

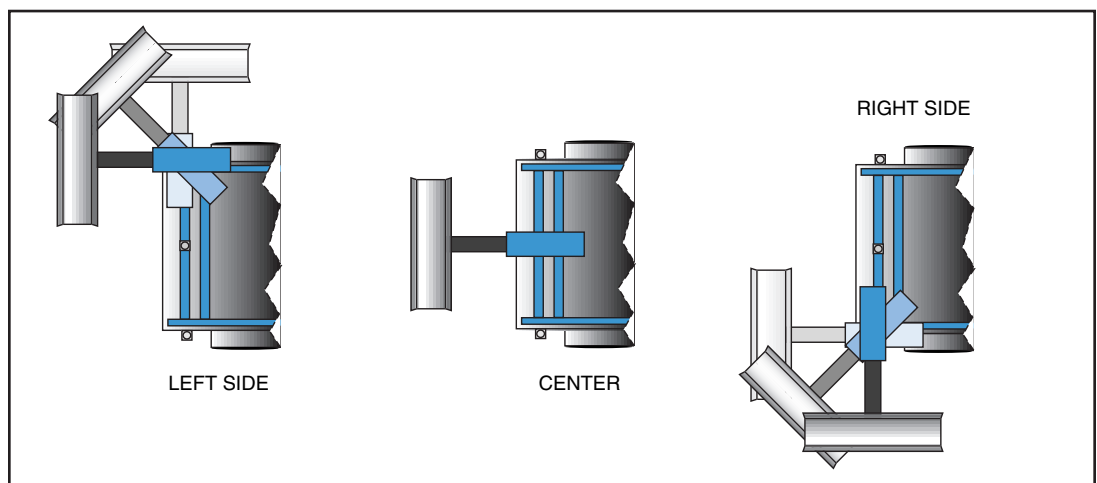

Figure 3

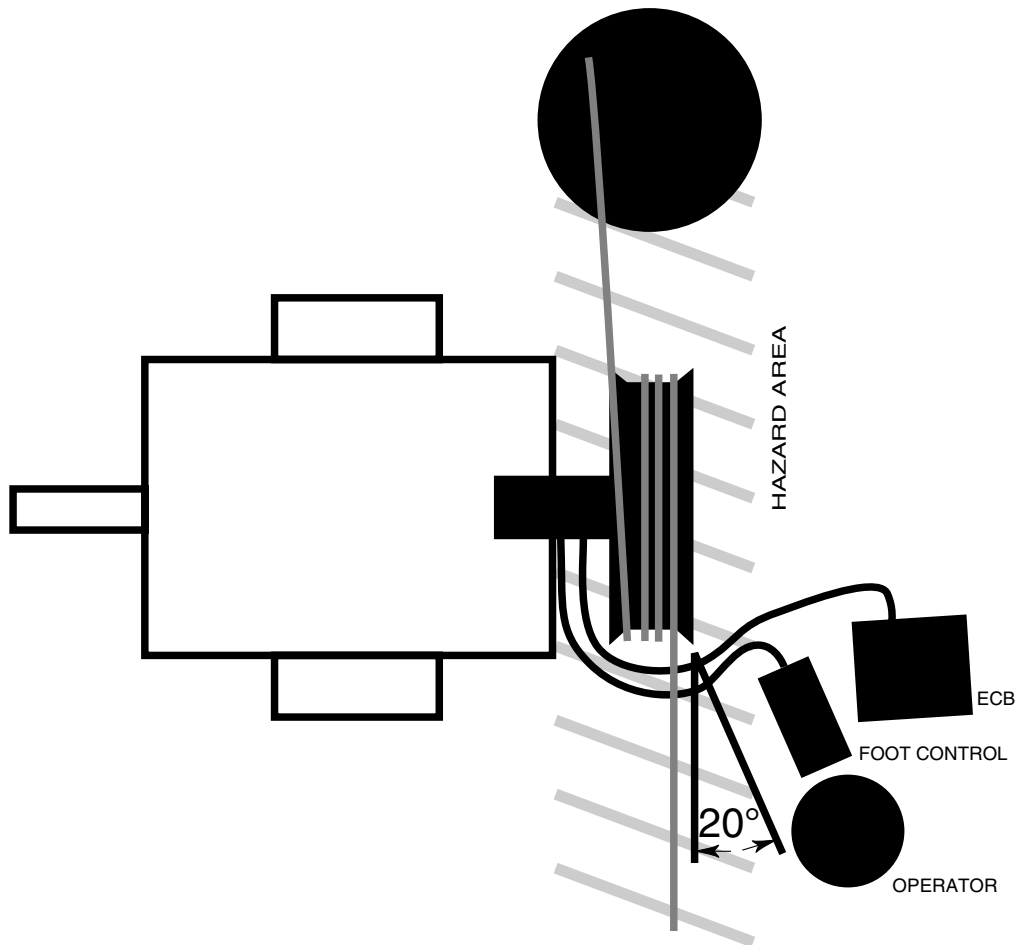

Figure 4

### C. POSITION THE TRAILER

Position the trailer (in the position determined in 4A) with the tow vehicle. It is not recommended that any other means be used to move the trailer.

## Set Up The Trailer

It is essential that the trailer set-up instructions are followed in order that they appear in this user guide and safety manual. Using the following procedures will allow the trailer to be set up in a short period of time and yield optimum performance.

### A. STABILIZING AND LEVELING THE TRAILER

1. Use only the adjustable jacks (3 supplied, replacement jack part number 02290764) for trailer stabilizing and leveling. Jacks must be placed securely only on jack mounts located on the trailer frame (figure 5). Do not attempt to locate jacks in any other position! To secure a jack in position, align jack with jack mount and insert safety pin. Raise and lower jacks by simply rotating crank handle.

**!WARNING:** Chock wheels and level trailer before setting up cable puller and other pulling equipment. Use wheel chocks and all three leveling jacks as described in the procedure below. Failure to properly level trailer may result in the trailers unexpected movement causing severe personal injury and equipment damage.



2. Begin to stabilize the trailer by placing a wheel chock (2 supplied) behind each trailer wheel (figure 6).



Figure 5



Figure 6



**!WARNING:** Load must be distributed evenly before unhitching trailer. Failure to do so may cause the trailer tongue to flip upward causing severe personal injury.

3. Remove trailer from tow vehicle. The trailer should be in position for cable pulling at this time (section 4). Use an adjustable jack on the front frame jack mount to lift the trailer from the tow vehicle (figure 7). Place jack in jack mount as described in section 5A-1 and then disconnect ball hitch or other hitch mechanism. Then lift trailer from tow vehicle by using the crank. Raise no more than necessary to clear tow vehicle.



Figure 7

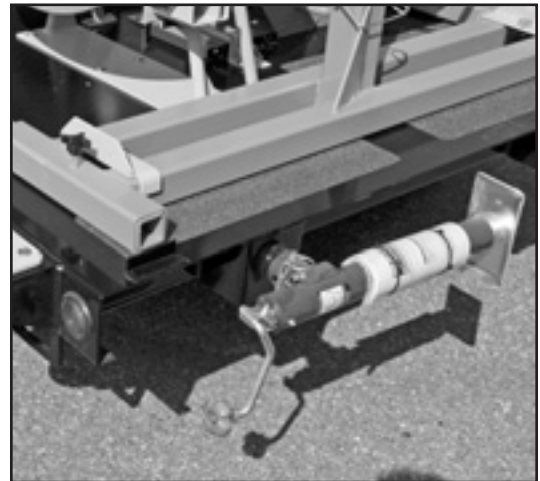

Figure 8

4. One jack will remain on the tongue of the trailer. Place the last two jacks at the rear corners of the trailer. Placement of rear jacks is critical to avoid getting in the way of the pulling equipment. Note that there are two jack mounts provided at each rear corner (figure 8).
5. Level the trailer by using the crank handles on the jacks. Raise and lower each jack to provide a level surface for the cable pulling equipment.



# Set Up The Cable Puller

## A. FOR CABLE PULLING FROM TRAILER

Move the cable puller from the travel position, if necessary, to achieve the best possible pulling position as determined in section 4. There are two steps to achieve this.

1. Change the placement of the cable puller on the trailer bed by inserting the puller into one of the two mounting holes on the side rails of the trailer frame. Note that the center (travel) position on the trailer bed already has its own mount. Pin the mount from below the trailer bed. Lower the cable puller on the mount.

**!CAUTION:** The cable puller is heavy (125 lbs.). Lift only with proper equipment or sufficient man power. Personal injury may result if improper lifting practices are used.

2. Adjust the cable puller on the mount, corner positions only (figure 9). Align holes in mount and cable puller. Place the lock pin (supplied) through the entire mount and hook to secure the cable puller.



Figure 9



Figure 10

## B. FOR CABLE PULLING WITH THE REMOTE MOUNTING STAND

In the event that the trailer cannot be positioned for optimum cable pulling operation, you may choose to use the remote mounting stand integrated on the trailer bed.

1. Remove the cable puller from the remote mounting stand first. Do not attempt to remove the remote mounting stand from the trailer bed with the cable puller attached.
2. Use a 1 1/8" wrench to remove the bolts securing the remote mounting stand to the trailer bed (figure 11).
3. Position the remote mounting stand on a level surface for cable pulling. Follow the guidelines in section 4.
4. Loosen the two screw-knobs on the base and slide the support tubes until centered. Retighten the two screw-knobs.

# 6.



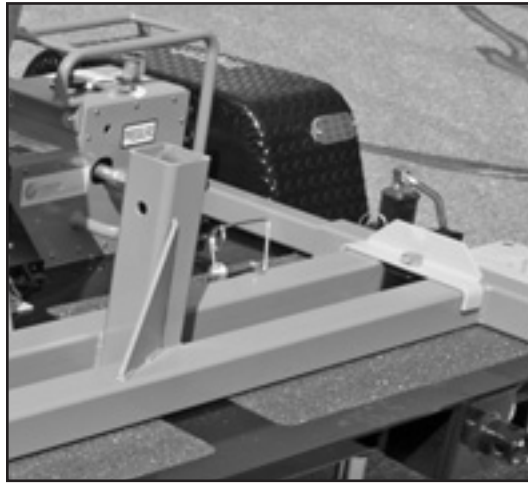

Figure 11

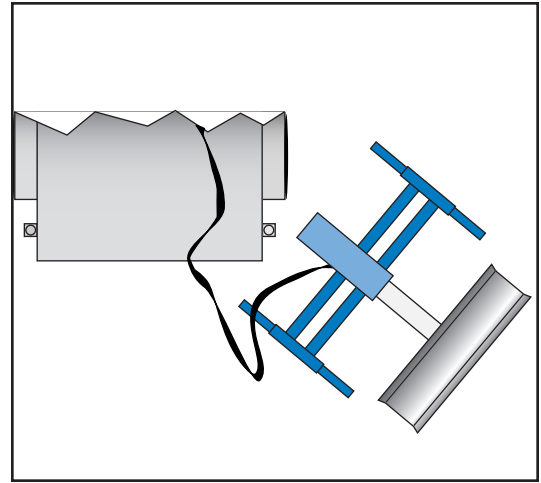

Figure 12

5. Mount the cable puller on the remote mounting stand. Be sure the capstan is placed between the support tubes, not over the support tubes (figure 12).

### C. UNPACK THE COMPONENTS

1. Remove the capstan from its storage rack and place on the cable puller. Align slots on capstan with pins on shaft and push on (figure 10). The capstan sleeve contains a spring that must be compressed all the way, then rotate clockwise until the capstan springs into place over the shaft pins. The pins on the shaft must be visible through the holes in the capstan sleeve. You should not be able to rotate the capstan at this point if it is properly installed.
2. Remove the foot control and hydraulic hoses from the trailer bed. Set aside for connection later.
3. Remove the Electronic Control Box, if equipped, and its power cord (supplied). Set aside for connection later.

### D. CONNECT THE HYDRAULICS



**!WARNING:** Escaping fluids under pressure can penetrate the skin and cause serious personal injury. Observe the following precautions to avoid hydraulic hazards:

1. Tighten all connections before applying pressure. Relieve pressure before disconnecting hoses.
2. Check for leaks with a piece of cardboard. Do not use hands!
3. Do not exceed working pressure of hydraulic hoses.
4. Visually inspect hoses regularly and replace if damaged.

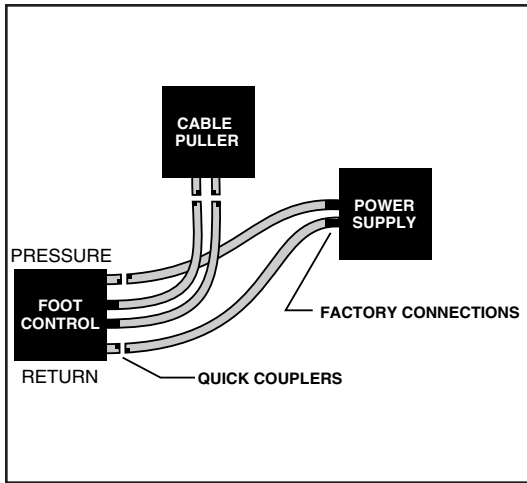

**Figure 13**



**Figure 14**

The hydraulic system on your Condux Fiber Optic Puller Trailer allows easy, accurate connections of hydraulic hoses for the foot control and power supply (figure 13). All connect points must be kept clean! Use the following steps to connect your hydraulic components:

1. Connect the foot control to the power unit. You'll find male and female quick couplers on the hose ends that mate to the foot control.
2. Connect the foot control to the cable puller. Use the male and female quick couplers on the hose ends to make the connection (figure 14).

# Set Up the Electronic Control System

## 7.

If the puller is not equipped with the electronic tension control system, go to section 8.

### A. SWITCH CONFIGURATION

Following is a brief explanation of each of the switches for the Condux Fiber Optic Cable Puller Electronic Control System. Detailed instructions for using the equipment follows these explanations.

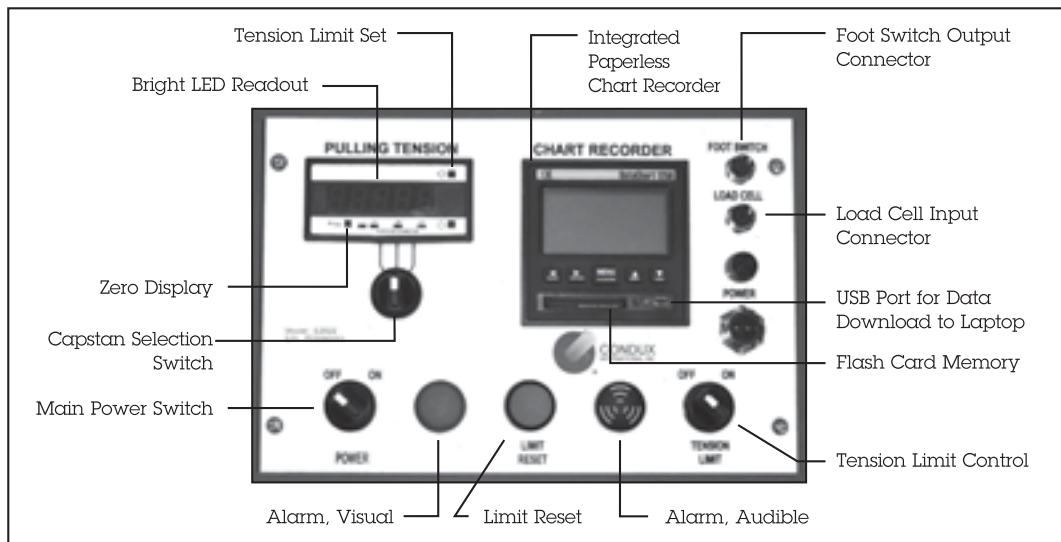

Figure 15

#### 1. Electronic Control Box Panel Switches (figure 15)

**Power:** Turns control box ON or OFF.

**Set Tension Limit:** Sets the limit where the control box will stop the puller. Press and hold **UP** or **DN** button to set the desired value.

**Tension Limit Control:** Determines if the puller will stop rotating when the preset tension limit is reached. Switch to **ON** to activate the hydraulic bypass valve and stop the puller when the tension limit is reached. Switch to **OFF** to disable the hydraulic bypass valve.

**Zero Display:** Set the display to zero before beginning. Press “Prog” button to zero display.

**Capstan Selection Switch:** Sets the control box to display the proper pulling forces depending on the size capstan used. Turn switch to set desired capstan diameter. The meter automatically calibrates the displayed force to the selected capstan size.

**Limit Reset:** Resets the control box and puller after the preset tension limit has been exceeded. Press button to reset hydraulic bypass valve and audible alarm. This can be done only when the tension is below the preset limit.



### B. CONNECT THE ELECTRONICS

**!DANGER:** The electronic control box is an electrical device. Electric shock hazards exist that could result in severe personal injury or death. Observe the following precautions:

- Do not expose electronic control box to water.
  - Do not remove cover of electronic control box (no user-serviceable parts inside). Refer servicing to qualified personnel.
  - The electronic control box power switch should be in the off position before connecting or disconnecting any cords.
1. Connect the male end of the 5-pin sensing cord to the female connector on the Electronic Control Box labeled “LOAD CELL”. (figure 16) Connect the female end of the cord to the male receptacle located near the load cell. (figure 16a). Before making these connections, ensure the receptacles are free of dirt and moisture. Do not modify this cord’s length.



Figure 16

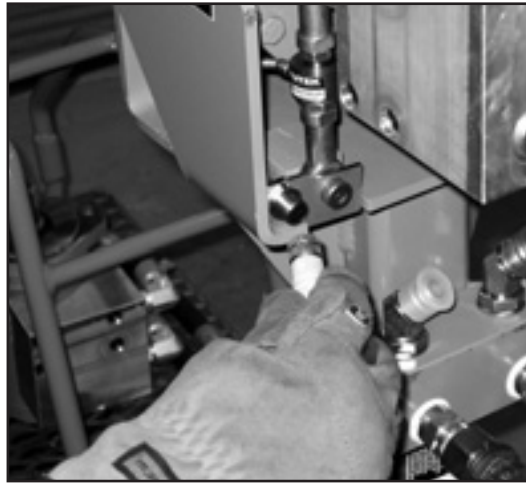

Figure 16a

Tighten the connector collars over the threaded portion of the receptacles. This prevents the cord from coming loose during operation. This cord is necessary to measure the tensions sensed by the load cell.

2. Connect the male end of the 3-pin footswitch control cord to the female connector on the Electronic Control Box labeled “FOOTSWITCH” figure 16b). Connect the female end of the control cord to the male receptacle located on the foot control valve assembly figure 16c). **NOTE:** If the connector on the foot switch is 2-pin, use the patch cord (08675926) included in the upgrade kit (08675920) to convert to the required connection. Before making these connections, ensure the receptacles are free of dirt and moisture. **Do not modify this cord’s length.**



Figure 16b



Figure 16c

Tighten the connector collars over the threaded portion of the receptacles. This prevents the cord from coming loose during operation. This cord is necessary to measure the tensions sensed by the load cell.



Figure 16d

3. The  $\frac{7}{8}$ " 2-pin connector on the front panel of the electronic control box supplies electrical power to the electronic control box. (figure 16d) This power can come from the power pack, a vehicles power point, or a lighter socket. The electronic control box requires 12 Volt DC power for proper operation.

4. Connect the power cord to the 2-pin connector labeled "POWER". Before making these connections, ensure the receptacle is free of dirt and moisture. Tighten the connector collar over the threaded portion of the receptacle. This

will prevent the cord from coming loose during operation. Connect the other end of the power cord to a 12 Volt DC power source.

### C. SETTING UP THE ELECTRONIC CONTROL BOX

The Condux Fiber Optic Tensiometer has been designed to give the operator continuous tension information and automatic shut-off control during a pull. The Electronic Control Box features an LED Display, Digital Graph Display, 256MB Flash Card, and a 3 capstan selection switch. A programmable overload set point with both visual and audible alarms is designed to disengage the cable puller should an overload occur. Navigator software is provided so pulling information can be downloaded onto any computer running Windows 2000<sup>®</sup> or XP<sup>®</sup>.



**!DANGER: The Main Power switch supplies power to the indicator and chart recorder. When a power supply is connected to the electronic control box, portions of it are energized. Follow all electrical equipment precautions.**

**!NOTE:** Always disconnect the power cord when the electronic control box is not in use. When the power cord is connected to the electronic control box, it energizes portions of the control box. If the power cord is left attached when the control box is not in use, it will drain the power supply.

1. Turn the power switch on the Electronic Control Box to the "ON" position (figure 15). Be sure that the sensor cords are properly connected before turning on power.
2. **Select the capstan size.** Turn the capstan selection switch so the appropriate channel is lit on the Meter. In order to get accurate results, the correct capstan size must be selected. The electronic control box is programmed to accurately return pull tension for Condux 12", 30", and 42" fiber optic capstans.
3. **Set the cable Tension Limit.** Press the "Prog" Button and ▼ button simultaneously. (figure 15) SP-1 will appear on the on the LED Screen. The screen will alternate between SP-1 and the current tension limit. Press the ▲ and ▼ buttons to increase or decrease the tension limit. Once the desired tension limit is set, press "Prog" to save the set point.

4. **Zero the display.** Press the “Prog” button.

5. **Alarms:** When Tension Limiter switch is in the “OFF” position the audio alarm will sound and the light will come on when the tension limit is reached. When the Tension Limiter switch is in the “ON” position the puller will also stop pulling when the tension limit is reached (figure 5)

**!CAUTION: Damage to cable may result from excessive pulling forces. Use precautions to safeguard against overload conditions.**



#### D. DIGITAL CHART RECORDER SET UP

The Digital Chart Recorder is the next generation Solid State Data Recorder/Panel Recorder. This instrument has all the capability of a traditional paper recorder – variable chart speeds, the ability to review historic data, see trends and more. All pull data is stored on the 256MB Compact Flash Card that comes with the unit.

1. **Name File** Press “MENU” button to enter the Menu screen. Use ▲ and ▼ arrows to scroll to RECORD MODE and press menu. Next, scroll to “NAME FILE” and press MENU. Use the ▲ and ▼ buttons to scroll through letters and the ◀ and ▶ buttons to move spaces. (figures 16e-h). Once the name is set press “MENU” button to go back to Record Mode. From Record Mode, ◀ or ▶ will return to Menu screen. Pressing ◀ or ▶ again will return to charting screen.



Figure 16e



Figure 16f



Figure 16g



Figure 16h

2. Set to Record Mode: If you are already in the Record Mode screen, use the ▲ and ▼ buttons to scroll to “ON”. If you are starting from the charting screen, press “MENU” and scroll to Record Mode. Press “MENU” again to enter Record Mode, and scroll to ON. Push the “MENU” button to put a check mark next to “ON”. Your unit is now ready to record. The red light on the Chart Recorder panel should turn on when unit is recording. Press the ◀ or ▶ to return to the Menu screen. Press ◀ or ▶ again to get back to the charting screen.

**!NOTE:** The recorder is time based, meaning if the recorder is not switched to "OFF" between pulls, the data recorder will report long time periods of zeros.

3. Set Sample Rate: Press the “MENU” button and the menu screen will appear. Using the ▲ and ▼ button, scroll to SAMPLE RATE. Press the “MENU” button and your list of sample rate options will appear. Select the sample rate you desire and press “MENU” to select. Press the ◀ or ▶ buttons twice to get back to the charting screen.

**!NOTE:** See Data Chart 1250 Manual on included CD for more information.

## **E. DATA DOWNLOAD INSTRUCTIONS**

The Running Line Tensiometers come with accessories for downloading your pull data: Navigation software, 256MB Flash Card, card reader and USB cable.

### **Downloading data to your computer via USB Cord**

1. Connect Recorder to PC or laptop with supplied USB cord
2. Turn ECB on \*and make sure that Record Mode has been turned to OFF.
3. Open Navigator software on PC
4. In Navigator software select “FILE” and “USE RECORDER”
5. Select Open to pull in pulling data from recorder.
6. Select your file and click “OK”

### **Downloading data to your computer via Flash Card**

1. Plug card reader into the PC’s USB connection.
2. \*Make sure that Record Mode has been turned to OFF. Remove Flash Card from ECB recorder and install into the card reader.
3. In Navigator software select open
4. A file screen will appear. Locate the removable drive and select pull data file.
5. Double click pull data file to load into Navigator software.

*See Navigator Software manual for additional information.*

# ***Operating The Power Unit***

## **8.**

### **A. FUEL AND THE FUEL TANK**

For optimum performance of the power unit, follow these instructions regarding fuel and the fuel tank:

1. For gas units use only unleaded gasoline with a minimum octane rating of 85. Ethanol blended fuels must contain 10% or less ethanol. Do not add oil to gas.



**!DANGER:** No smoking or open flame in the work area. An explosion hazard exists as the trailer houses a gasoline tank.



## B. FINAL INSPECTION BEFORE STARTING POWER UNIT

1. Inspect the jobsite for safe equipment layout.
2. Be sure the trailer is stable and level.
3. Supply all jobsite personnel with safety equipment (section 3).
4. Check engine oil level. See Briggs & Stratton Owner's Manual (supplied).
5. Check hydraulic fluid level.
6. Check hydraulic connections.
7. Check electronic connections if using the Electronic Control Box.

## C. START THE POWER UNIT

1. Turn on the ignition switch.
2. The Hydraulic Power Pack has an electric starter. The battery must be charged to start engine. Jump starting is not recommended.
3. Begin the cable pull. There is no information in this manual on the operation of the Condux Fiber Optic Cable Puller. **You must read and understand all operating instructions and safety messages in the Condux Fiber Optic Cable Puller User Guide & Safety Manual (Part No. 08675199) before operating that equipment (figure 17 & 18).**

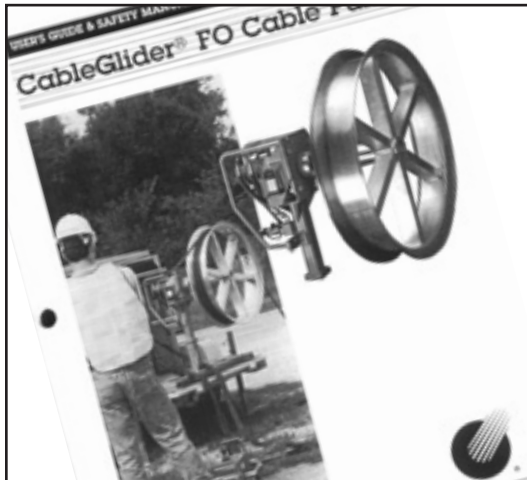

Figure 17

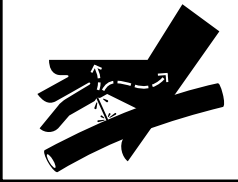

Figure 18

# When The Cable Pull Is Complete

# 9.

**⚠ WARNING**



## A. STOP THE POWER UNIT

1. Turn throttle control to the slow position.
2. Turn the ignition switch for the power unit to the off position.

**!WARNING:** Escaping fluids under pressure can penetrate the skin and cause serious personal injury. Observe the following precautions to avoid hydraulic hazards:

1. Relieve pressure before disconnecting hoses.
2. Check for leaks with a piece of cardboard. Do not use hands!

## B. REMOVE PRESSURE FROM HYDRAULIC SYSTEM

***Lift up and down on the foot control pedal to relieve back pressure in the hydraulic system. Repeat at least 3 times to ensure relief. Do not disconnect hoses under pressure!***

## C. REMOVE HYDRAULIC HOSES

It is extremely important that all hydraulic connections be kept free of dirt and particles (figure 19). Use hose end caps (supplied). A contaminated hydraulic system will affect the operation of the cable puller and may invalidate your product warranty.

1. Using the quick couplers, disconnect power supply hose at the foot control. Cap the power supply hose and place on hose rack. Do not disconnect the power supply hose at the power unit (figure 20).
2. Using the quick couplers, disconnect the foot control feed line at the cable puller. Cap all ends.



Figure 19

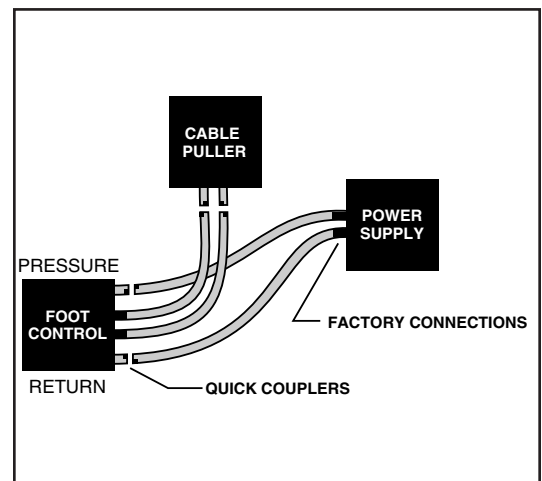

Figure 20

#### D. DISCONNECT THE ELECTRONICS

**!DANGER:** The Electronic Control Box is an electrical device. Electric shock hazard exists that could result in severe personal injury or death. Observe the following precautions to avoid electrical hazards:

1. Do not remove cover of Electronic Control Box. No user serviceable parts inside. Refer servicing to qualified service personnel.
2. The Electronic Control Box power switch should be in the off position before connecting or disconnecting any cords.
  1. Turn off Electronic Control Box before disconnecting any cords.
  2. Remove power supply cord at the power pack and Electronic Control Box. Wrap and stow in trailer.
  3. Disconnect the Electronic Control Box control cord at the cable puller. Do not disconnect the control cord at the Electronic Control Box, it is permanently attached.



## ***Additional Takedown Procedures***

#### A. REMOVE CAPSTAN FROM CABLE PULLER

1. Push in on the capstan and rotate counterclockwise until it springs out slightly.
2. Align slot on capstan with the pins on spindle and pull off.
3. Mount the capstan on the trailer by sliding the hub of the capstan over the spindle mount on the trailer (figure 21). Capstan must be mounted exactly as shown to prevent damage. Tie down with strap (supplied). Span a minimum of three capstan spokes with the tie down strap for a tight fit.

**!CAUTION:** The cable puller is heavy (125 lbs.). Lift only with proper equipment or sufficient man power. Personal injury may result if improper lifting practices are used.

#### B. RETURN CABLE PULLER TO TRAVEL POSITION

Follow the procedure below if you have moved the cable puller from its travel position. If you have used the remote mounting stand, it must be secured back on the trailer before returning the cable puller to the travel position.

1. The center position is the only travel position recommended for the cable puller. This mount does not require the additional mount used for the side mount locations.
2. Lower the cable puller onto the center mount and pin in place. The cable puller must travel with the capstan spindle pointing toward the passengers side of the trailer (figure 21). Other components will not stow properly if this position is not used.





Figure 21

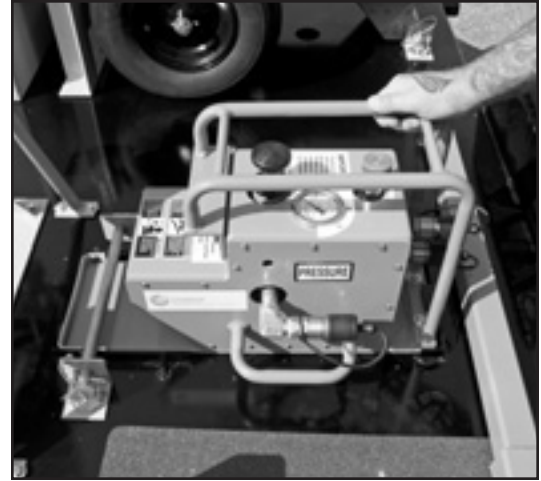

Figure 22

### C. LOAD FOOT CONTROL UNIT

Set foot control into travel hold on trailer bed (figure 22). Place hoses in storage box.

### D. PREPARE UNIT FOR TRANSPORT

1. Stow remaining equipment in compartment on trailer.

## *Trailer Towing Safety Instructions*

**A.**

### APPENDIX

**!WARNING:** Observe the following safety instructions when transporting the Condux Fiber Optic Cable Puller Trailer. Observe local, state, and federal laws governing trailer towing. Also follow the tow vehicles operating instructions for trailer towing. Failure to do so may result in severe personal injury and equipment damage.

1. Check that coupler hitch and ball or pintle hitch and hook are correct size.
2. Adjust trailer tongue to proper hitch height.
3. Secure fiber optic puller and capstan.
4. Disconnect electronics and turn off power pack.
5. Check trailer load for balance and capacity.
6. Attach trailer to towing vehicle.
7. Latch and lock ball coupler or pintle hook.
8. Cross safety chains beneath hitch and attach to towing vehicle.
9. Connect and check lighting.
10. Remove leveling jacks.
11. Remove wheel chocks.
12. Tighten wheel lug nuts and check tire pressure.

## ***Routine Maintenance***

- A. Clean and lubricate jack assemblies regularly to ensure ease of operation.
- B. Inspect tires for proper wear and always keep inflated to the specification denoted on the sidewall of the tire.
- C. Inspect lighting and replace bulbs as required.
- D. Follow the engine manufacturer's maintenance schedule as described in the Briggs and Stratton Owners Manual (supplied).
- E. Follow proper care and maintenance of hydraulic systems.



**APPENDIX**

## ***Replacement Parts***

<b>Part Number</b>	<b>Description</b>
02290764	Stabilizer Jacks
02266000	Wheel Chocks
08675669	Locking Pin (Power Unit)
02289015	Quick Pin (Power Unit)
02245400	Hair Pin 1/8in – 3/4in Shaft (Power Unit)
08675694	Locking Pin (Foot Control)
02289015	Quick Pin (Foot Control)
02289016	Quick Pin (Capstan)
02269688	Quick Pin (Toolbox)
08675595	Puller Retaining Strap
02129101	3/4 x 2in Hex Capscrew Gr5 (Retaining Strap)
08675674	Capstan Mount Spacer
02021400	1/4 x 3/4 Hex Capscrew Gr5 (Mount Spacer)



**APPENDIX**

# ***Notes***

# ***Limited Warranty***

Condux International, Inc. extends the following warranty to the original purchaser of these goods for use, subject to the qualifications indicated:

Condux International, Incorporated warrants to the original purchaser for use that the goods or any component thereof manufactured by Condux International will be free from defects in workmanship for a period of one year from the date of purchase, provided such goods are installed, maintained, and used in accordance with Condux's written instructions.

Components not manufactured by Condux International but used within the assembly provided by Condux International are subject to the warranty period as specified by the individual manufacturer of said component, provided such goods are installed, maintained, and used in accordance with Condux's and the original manufacturer's written instructions.

Condux's sole liability and the purchaser's sole remedy for a failure of goods under this limited warranty, and for any and all claims arising out of the purchase and use of the goods, shall be limited to the repair or replacement of the goods that do not conform to this warranty.

To obtain repair or replacement service under the limited warranty, the purchaser must contact the factory for a Return Material Authorization (RMA). Once obtained, send the RMA along with the defective part or goods, transportation prepaid, to: Condux International, Inc.

145 Kingswood Drive  
Mankato, MN 56001 USA

**THERE ARE NO EXPRESS WARRANTIES COVERING THESE GOODS OTHER THAN AS SET FORTH ABOVE. THE IMPLIED WARRANTIES OR MERCHANTABILITY AND FITNESS FOR A PARTICULAR PURPOSE ARE LIMITED IN DURATION TO ONE YEAR FROM DATE OF PURCHASE.**

**CONDUX ASSUMES NO LIABILITY IN CONNECTION WITH THE INSTALLATION OR USE OF THIS PRODUCT, EXCEPT AS STATED IN THIS LIMITED WARRANTY. CONDUX WILL IN NO EVENT BE LIABLE FOR INCIDENTAL OR CONSEQUENTIAL DAMAGES.**



**Condux International, Inc.**

---

P.O. Box 247 • 145 Kingswood Drive, Mankato, MN 56002-0247 USA

1-507-387-6576 • 1-800-533-2077 • FAX 1-507-387-1442

Internet: <http://www.condux.com>

© Copyright 2012, Condux International, Inc.

Printed in USA

Literature Part Number: 08675705

Revision Number: 1.0